



POLYGONAL TAPER TOOL HOLDERS

TAKE YOUR MACHINING TO THE NEXT LEVEL

POLYGONAL TAPER TOOLING



POLYGONAL TAPER TOOLING



ISO 26623-1

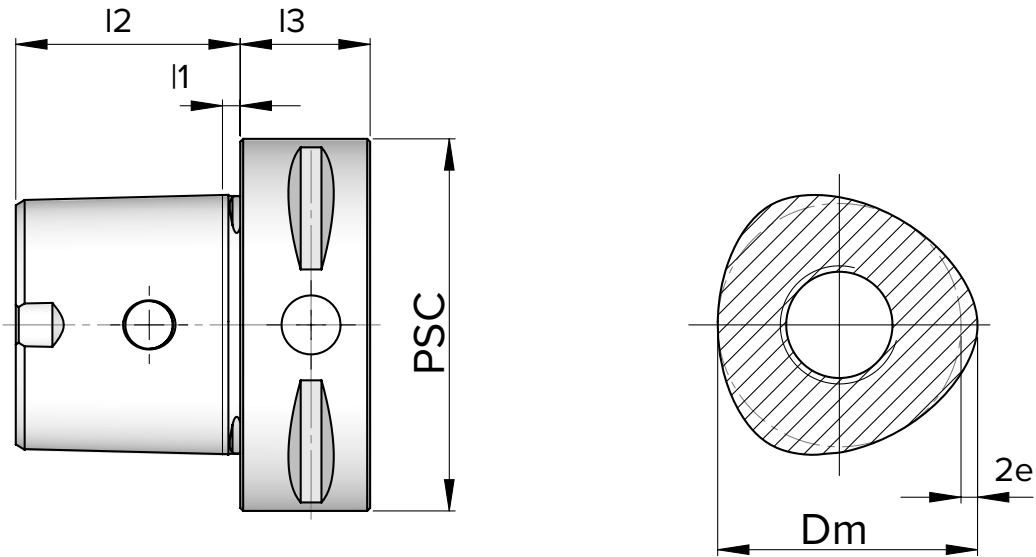

PSC	Size	D_m	e	l_1	l_2	l_3 min.
40	C4	28	0.90	2.50	24	20
50	C5	35	1.12	3.00	30	20
63	C6	44	1.40	3.00	38	22
80	C8	55	2.00	3.00	48	30

Material: Case hardened steel with min. 900 N/mm² of core tensile strength.

Execution: Case hardened 58±2 Hrc. Depth of case 0.6 to 0.8 mm. Black oxidized.

Accuracy: Taper angle AT3 quality class. Roughness $R_a < 0.2$

All dimensions in this catalogue are in millimeters unless otherwise specified.

POLYGONAL TAPER TOOLING

FULL POTENTIAL MACHINING

Polygonal taper tool holders help you bring your machining to a new level



As precisely defined per ISO 26623, PSC interface features unique tapered polygon which serves as a main element in torque transmitting, centering, and clamping. With double contact on both face and taper, as well as great cross-sectional strength, this interface is unrivaled in terms of high clamping force and bending stiffness.

Combination of these excellent properties give PSC interface clear advantage over HSK and 7/24 tapers with about 2x better bending and torsional characteristics. This translates into greater process stability, higher productivity, and lower costs.



Key Attributes of Polygonal Tool Holders:

- Extremely stable and rigid connection between tool and the machine
- High torque and bending forces transmission due to simultaneous tapered polygon and face contact with machine spindle
- Self centering ability due to unique design
- Internal coolant supply, directly to the tool tip
- Best solution for all processes - both in turning and milling
- Modular design for flexible tooling
- Standardized interface as per ISO 26623
- 4 sizes, flange diameters 40-50-63-80 mm (sizes C4-C5-C6-C8)



TURNING MADE BETTER

PSC turning tool holders are go-to solution for maximizing process efficiency

Used in both standard turn centers and hybrid mill-turn machines, PSC turning tool holders enable fast tool change solution for reduced down-time and increased productivity without compromise on stability and rigidity. Additionally, direct high pressure coolant nozzles increase tool life with higher feeds and speeds.

More time making chips and less time in unwanted stops makes investment in Polygonal taper tool holders a great choice with a fast return.

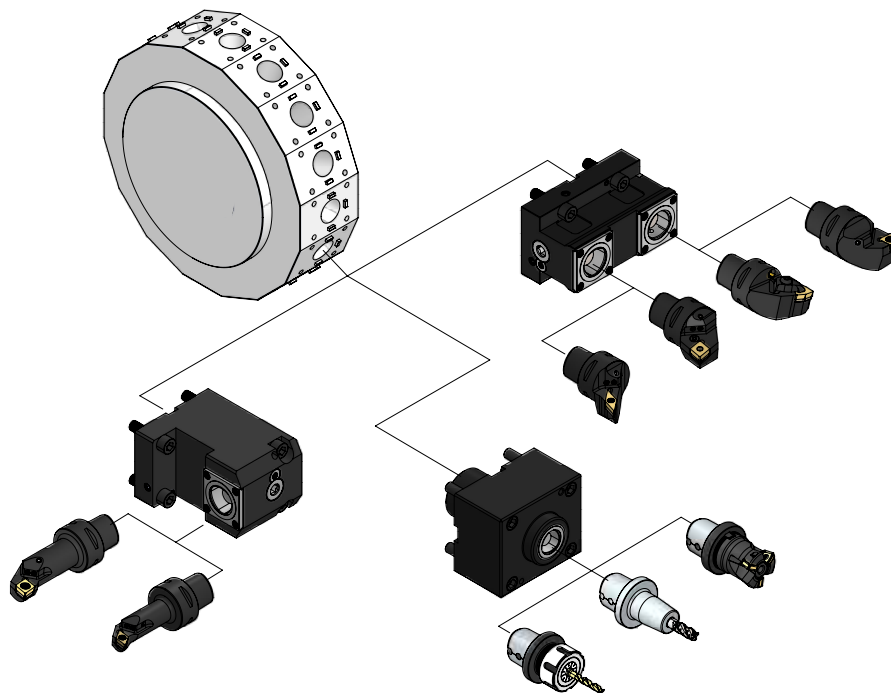

Key Benefits of PSC Turning Tools:

- Reduced setup and tool change time - maximum utilization of the machine
- Increased stability and versatility - in vertical lathes, multi-tasking machining centers and machining centers with turning possibilities
- Ultimate repeatability - allowing online tool presetting
- Reduced tool inventory and storage space in workshop - due to universal interface for both turning and milling
- Self centering system provides high precision and repeatability
- Carbide shims to prevent insert seats from damage
- Quick change, monobloc system without additional interfaces

SHORT ADAPTER DRIVES MORE BENEFITS

Driven and static tools on your machine are best paired with short polygonal taper tool holders

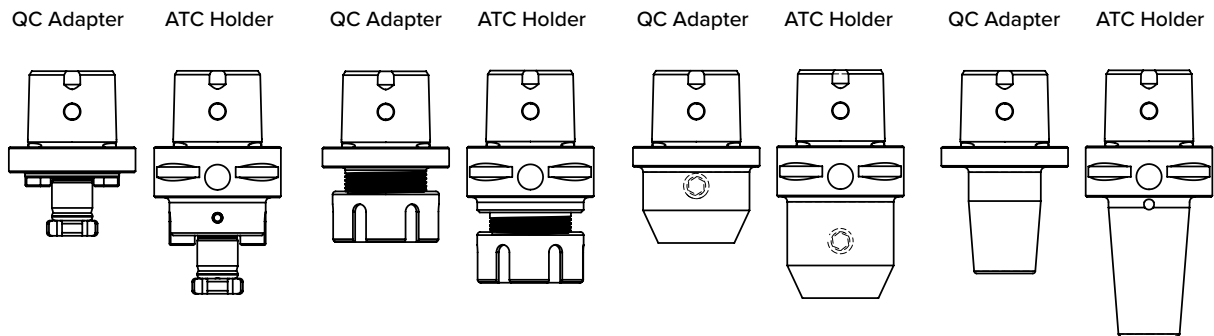

Quick-change PSC adapters have exactly the same ISO 26223-1 taper as normal PSC adapters key with one difference - absence of gripper groove for automatic tool change (ATC). As a result, tool length is reduced which helps achieve stable process hence higher quality parts and more efficient machining.

Key Benefits of Short Adapters:

- Allows for more cutting tool length
- Greater cutting stability
- Extends tool life and accuracy due to reduced tool runout
- Increases surface finish
- Decreases load on driven toolholder bearings
- Reduces setup and tool change time



HIGH PRECISION AS STANDARD

In order to ensure highest levels of quality, precision, and compatibility, we manufacture 26623-1 tool holders using the same special inspection and manufacturing equipment and procedures as other major suppliers in the industry.

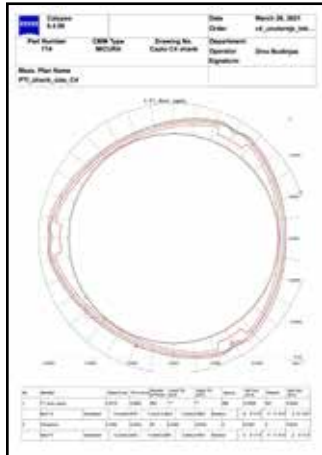

- Laboratory quality certified inspection equipment
- Inspection protocols equal to those of major industry competitors
- State-of-the-art manufacturing equipment
- ISO 9001 certified company
- AUKOM certified quality inspectors
- ISO 26623-1 compliant



POLYGONAL TAPER TOOLING

TURNING TOOL HOLDERS - EXTERNAL

Wedge Clamp
Direct Coolant Supply

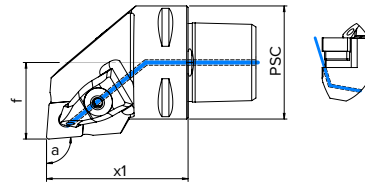

Size	Code	Orientation	Insert	PSC	a	x1	f
C4	C4-DCLNR-27050-12CP	Right	CN..1204..	40	95°	50	27
	C4-DCLNL-27050-12CP	Left	CN..1204..	40	95°	50	27
C5	C5-DCLNR-35060-12CP	Right	CN..1204..	50	95°	60	35
	C5-DCLNL-35060-12CP	Left	CN..1204..	50	95°	60	35
C6	C6-DCLNR-45065-12CP	Right	CN..1204..	63	95°	65	45
	C6-DCLNL-45065-12CP	Left	CN..1204..	63	95°	65	45
C8	C8-DCLNR-55080-12CP	Right	CN..1204..	80	95°	80	55
	C8-DCLNL-55080-12CP	Left	CN..1204..	80	95°	80	55

	Clamp	Clamp Screw	Shim	Shim Screw	Key	O-Ring Set
Spare Parts						
Code:	SPKR/L	VPA-0620-CP	PPPC-12	VPP-0512-KG	KLJ-I30	OR-VPA-CP





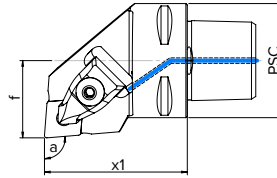

POLYGONAL TAPER TOOLING

TURNING TOOL HOLDERS - EXTERNAL

Wedge Clamp
External Coolant Supply



Size	Code	Orientation	Insert	PSC	a	x1	f
C4	C4-DCLNR-27050-12	Right	CN..1204..	40	95°	50	27
	C4-DCLNL-27050-12	Left	CN..1204..	40	95°	50	27
C5	C5-DCLNR-35060-12	Right	CN..1204..	50	95°	60	35
	C5-DCLNL-35060-12	Left	CN..1204..	50	95°	60	35
C6	C6-DCLNR-45065-12	Right	CN..1204..	63	95°	65	45
	C6-DCLNL-45065-12	Left	CN..1204..	63	95°	65	45
C8	C8-DCLNR-55080-12	Right	CN..1204..	80	95°	80	55
	C8-DCLNL-55080-12	Left	CN..1204..	80	95°	80	55

	Clamp	Clamp Screw	Shim	Shim Screw	Key	Nozzle	Spring
Spare Parts							
Code:	SPK	VPA-0520	PPPC-12	VPP-0512-KG	KLJ-I30	ML-M10	OPP-02

POLYGONAL TAPER TOOLING

TURNING TOOL HOLDERS - EXTERNAL

Wedge Clamp
Direct Coolant Supply

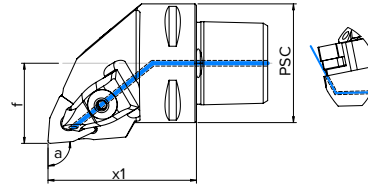

Size	Code	Orientation	Insert	PSC	a	x1	f
C4	C4-DWLN-27050-08CP	Right	WN..0804..	40	95°	50	27
	C4-DWLN-27050-08CP	Left	WN..0804..	40	95°	50	27
C5	C5-DWLN-35060-08CP	Right	WN..0804..	50	95°	60	35
	C5-DWLN-35060-08CP	Left	WN..0804..	50	95°	60	35
C6	C6-DWLN-45065-08CP	Right	WN..0804..	63	95°	65	45
	C6-DWLN-45065-08CP	Left	WN..0804..	63	95°	65	45
C8	C8-DWLN-55080-08CP	Right	WN..0804..	80	95°	80	55
	C8-DWLN-55080-08CP	Left	WN..0804..	80	95°	80	55

	Clamp	Clamp Screw	Shim	Shim Screw	Key	O-Ring Set
Spare Parts						
Code:	SPKR/L	VPA-0620.CP	PPPW-08	VPP-0512-KG	KLJ-I30	OR-VPA-CP

POLYGONAL TAPER TOOLING

TURNING TOOL HOLDERS - EXTERNAL

Wedge Clamp
External Coolant Supply

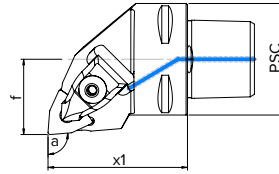

Size	Code	Orientation	Insert	PSC	a	x1	f
C4	C4-DWLN-27050-08	Right	WN..0804..	40	95°	50	27
	C4-DWLNL-27050-08	Left	WN..0804..	40	95°	50	27
C5	C5-DWLN-35060-08	Right	WN..0804..	50	95°	60	35
	C5-DWLNL-35060-08	Left	WN..0804..	50	95°	60	35
C6	C6-DWLN-45065-08	Right	WN..0804..	63	95°	65	45
	C6-DWLNL-45065-08	Left	WN..0804..	63	95°	65	45
C8	C8-DWLN-55080-08	Right	WN..0804..	80	95°	80	55
	C8-DWLNL-55080-08	Left	WN..0804..	80	95°	80	55

	Clamp	Clamp Screw	Shim	Shim Screw	Key	Nozzle	Spring
Spare Parts							
Code:	SPK	VPA-0520	PPPW-08	VPP-0512-KG	KLJ-I30	ML-M10	OPP-02

POLYGONAL TAPER TOOLING

TURNING TOOL HOLDERS - EXTERNAL

Wedge Clamp
Direct Coolant Supply

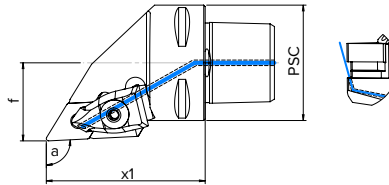

Size	Code	Orientation	Insert	PSC	a	x1	f
C4	C4-DDJNR-27055-15CP	Right	DN..1506..	40	93°	55	27
	C4-DDJNL-27055-15CP	Left	DN..1506..	40	93°	55	27
C5	C5-DDJNR-35060-15CP	Right	DN..1506..	50	93°	60	35
	C5-DDJNL-35060-15CP	Left	DN..1506..	50	93°	60	35
C6	C6-DDJNR-45065-15CP	Right	DN..1506..	63	93°	65	45
	C6-DDJNL-45065-15CP	Left	DN..1506..	63	93°	65	45
C8	C8-DDJNR-55080-15CP	Right	DN..1506..	80	93°	80	55
	C8-DDJNL-55080-15CP	Left	DN..1506..	80	93°	80	55

	Clamp	Clamp Screw	Shim	Shim Screw	Key	O-Ring Set
Spare Parts						
Code:	SPKR/L	VPA-0620-CP	PPPD-15	VPP-0512-KG	KLJ-I30	OR-VPA-CP





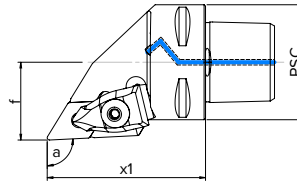

POLYGONAL TAPER TOOLING

TURNING TOOL HOLDERS - EXTERNAL

Wedge Clamp
External Coolant Supply



Size	Code	Orientation	Insert	PSC	a	x1	f
C4	C4-DDJNR-27055-15	Right	DN..1506..	40	93°	55	27
	C4-DDJNL-27055-15	Left	DN..1506..	40	93°	55	27
C5	C5-DDJNR-35060-15	Right	DN..1506..	50	93°	60	35
	C5-DDJNL-35060-15	Left	DN..1506..	50	93°	60	35
C6	C6-DDJNR-45065-15	Right	DN..1506..	63	93°	65	45
	C6-DDJNL-45065-15	Left	DN..1506..	63	93°	65	45
C8	C8-DDJNR-55080-15	Right	DN..1506..	80	93°	80	55
	C8-DDJNL-55080-15	Left	DN..1506..	80	93°	80	55

	Clamp	Clamp Screw	Shim	Shim Screw	Key	Nozzle	Spring
Spare Parts							
Code:	SPK	VPA-0520	PPPD-15	VPP-0512-KG	KLJ-I30	ML-M10	OPP-02

POLYGONAL TAPER TOOLING

TURNING TOOL HOLDERS - EXTERNAL

Wedge Clamp
External Coolant Supply

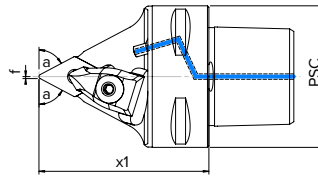

Size	Code	Orientation	Insert	PSC	a	x1	f
C4	C4-DDNNN-00055-15CP	Neutral	DN..1506..	40	62.5°	55	0.5
C5	C5-DDNNN-00060-15CP	Neutral	DN..1506..	50	62.5°	60	0.5
C6	C6-DDNNN-00065-15CP	Neutral	DN..1506..	63	62.5°	65	0.5
C8	C8-DDNNN-00080-15CP	Neutral	DN..1506..	80	62.5°	80	0.5

	Clamp	Clamp Screw	Shim	Shim Screw	Key	Nozzle	Spring
Spare Parts							
Code:	SPK	VPA-0520	PPPD-15	VPP-0512-KG	KLJ-I30	ML-M10	OPP-02

TURNING TOOL HOLDERS - EXTERNAL

Wedge Clamp
External Coolant Supply

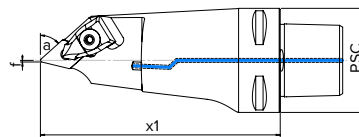

Size	Code	Orientation	Insert	PSC	a	x1	f
C5	C5-DDMNL-00115-15	Left	DN..1506..	50	48°	115	1
C6	C6-DDMNL-33120-15	Left	DN..1506..	63	48°	120	33
C8	C8-DDMNL-00160-15	Left	DN..1506..	80	48°	160	1

	Clamp	Clamp Screw	Shim	Shim Screw	Key	Nozzle	Spring
Spare Parts							
Code:	SPK	VPA-0520	PPPD-15	VPP-0512-KG	KLJ-I30	ML-M10	OPP-02

POLYGONAL TAPER TOOLING

TURNING TOOL HOLDERS - EXTERNAL

Wedge Clamp
External Coolant Supply

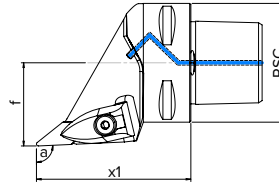

Size	Code	Orientation	Insert	PSC	a	x1	f
C4	C4-DVJNR-27062-16CP	Right	VN..1604..	40	93°	62	27
	C4-DVJNL-27062-16CP	Left	VN..1604..	40	93°	62	27
C5	C5-DVJNR-35065-16CP	Right	VN..1604..	50	93°	65	35
	C5-DVJNL-35065-16CP	Left	VN..1604..	50	93°	65	35
C6	C6-DVJNR-45065-16CP	Right	VN..1604..	63	93°	65	45
	C6-DVJNL-45065-16CP	Left	VN..1604..	63	93°	65	45
C8	C8-DVJNR-55080-16CP	Right	VN..1604..	80	93°	80	55
	C8-DVJNL-55080-16CP	Left	VN..1604..	80	93°	80	55

	Clamp	Clamp Screw	Shim	Shim Screw	Key	Nozzle	Spring
Spare Parts							
Code:	SPD	VPA-0520	PPPV-16	VPP-0512-RG	KLJ-130	ML-M10	OPP-02

POLYGONAL TAPER TOOLING

TURNING TOOL HOLDERS - EXTERNAL

Wedge Clamp
External Coolant Supply

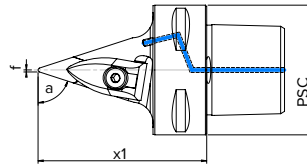

Size	Code	Orientation	Insert	PSC	a	x1	f
C4	C4-DVVNN-00062-16CP	Neutral	VN..1604..	40	72.5°	62	0
C5	C5-DVVNN-00065-16CP	Neutral	VN..1604..	50	72.5°	65	0
C6	C6-DVVNN-00065-16CP	Neutral	VN..1604..	63	72.5°	65	0
C8	C8-DVVNN-00080-16CP	Neutral	VN..1604..	80	72.5°	80	0

	Clamp	Clamp Screw	Shim	Shim Screw	Key	Nozzle	Spring
Spare Parts							
Code:	SPD	VPA-0520	PPPV-16	VPP-0512-RG	KLJ-I30	ML-M10	OPP-02

TURNING TOOL HOLDERS - EXTERNAL

Wedge Clamp
External Coolant Supply

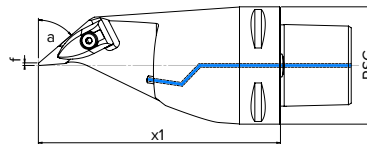

Size	Code	Orientation	Insert	PSC	a	x1	f
C6	C6-DVMNL-00130-16	Left	VN..1604..	63	50°	130	1.2
C8	C8-DVMNL-00160-16	Left	VN..1604..	80	50°	160	1.2

	Clamp	Clamp Screw	Shim	Shim Screw	Key	Nozzle	Spring
Spare Parts							
Code:	SPD	VPA-0520	PPPV-16	VPP-0512-RG	KLJ-I30	ML-M10	OPP-02





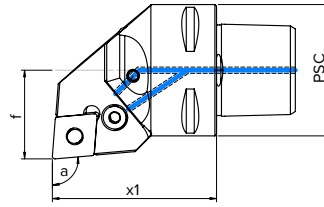

POLYGONAL TAPER TOOLING

TURNING TOOL HOLDERS - EXTERNAL

Lever-Lock Clamp
Direct Coolant Supply



Size	Code	Orientation	Insert	PSC	a	x1	f
C4	C4-PCLNR-27050-12CP	Right	CN..1204..	40	95°	50	27
	C4-PCLNL-27050-12CP	Left	CN..1204..	40	95°	50	27
C5	C5-PCLNR-35060-12CP	Right	CN..1204..	50	95°	60	35
	C5-PCLNL-35060-12CP	Left	CN..1204..	50	95°	60	35
C6	C6-PCLNR-45065-12CP	Right	CN..1204..	63	95°	65	45
	C6-PCLNL-45065-12CP	Left	CN..1204..	63	95°	65	45
C6	C6-PCLNR-45165-12CP	Right	CN..1204..	63	95°	165	45
	C6-PCLNL-45165-12CP	Left	CN..1204..	63	95°	165	45
C8	C8-PCLNR-55080-12CP	Right	CN..1204..	80	95°	80	55
	C8-PCLNL-55080-12CP	Left	CN..1204..	80	95°	80	55

	Lever	Lever Screw	Shim	Shim Pin	Key	Nozzle
Spare Parts						
Code:	POL-01	VPOL-0819	PPPC-12	OPP-01	KLJ-I30	ML-M4





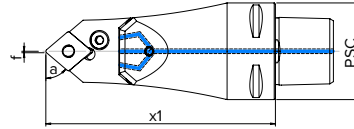

POLYGONAL TAPER TOOLING

TURNING TOOL HOLDERS - EXTERNAL

Lever-Lock Clamp
Direct Coolant Supply



Size	Code	Orientation	Insert	PSC	a	x1	f
C4	C4-PCMNN-00095-12CP	Neutral	CN..1204..	40	50°	95	0
C5	C5-PCMNN-00115-12CP	Neutral	CN..1204..	50	50°	115	0
C6	C6-PCMNN-00115-12CP	Neutral	CN..1204..	63	50°	115	0
C8	C8-PCMNN-00150-12CP	Neutral	CN..1204..	80	50°	150	0

	Lever	Lever Screw	Shim	Shim Pin	Key	Nozzle
Spare Parts						
Code:	POL-01	VPOL-0819	PPPC-12	OPP-01	KLJ-I30	ML-M4

POLYGONAL TAPER TOOLING

TURNING TOOL HOLDERS - EXTERNAL

Lever-Lock Clamp
Direct Coolant Supply

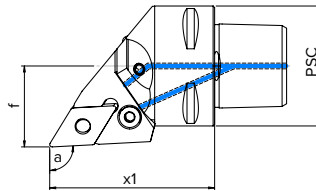

Size	Code	Orientation	Insert	PSC	a	x1	f
C4	C4-PDJNR-27050-15CP	Right	DN..1506..	40	93°	55	27
	C4-PDJNL-27050-15CP	Left	DN..1506..	40	93°	55	27
C5	C5-PDJNR-35060-15CP	Right	DN..1506..	50	93°	60	35
	C5-PDJNL-35060-15CP	Left	DN..1506..	50	93°	60	35
C6	C6-PDJNR-45065-15CP	Right	DN..1506..	63	93°	65	45
	C6-PDJNL-45065-15CP	Left	DN..1506..	63	93°	65	45
C6	C6-PDJNR-45165-15CP	Right	DN..1506..	63	93°	165	45
	C6-PDJNL-45165-15CP	Left	DN..1506..	63	93°	165	45
C8	C8-PDJNR-55080-15CP	Right	DN..1506..	80	93°	80	55
	C8-PDJNL-55080-15CP	Left	DN..1506..	80	93°	80	55

	Lever	Lever Screw	Shim	Shim Pin	Key	Nozzle
Spare Parts						
Code:	POL-02	VPOL-0819	PPPD-15	OPP-01	KLJ-I30	ML-M4

POLYGONAL TAPER TOOLING

TURNING TOOL HOLDERS - EXTERNAL

Lever-Lock Clamp
External Coolant Supply

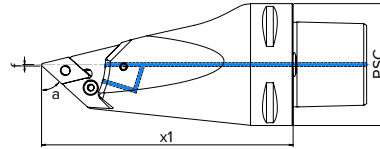

Size	Code	Orientation	Insert	PSC	a	x1	f
C6	C6-PDMNR-00130-15CP	Right	DN..1506..	63	93°	130	0.6
	C6-PDMNL-00130-15CP	Left	DN..1506..	63	93°	130	0.6

	Lever	Lever Screw	Shim	Shim Pin	Key	Nozzle
Spare Parts						
Code:	POL-02	VPOL-0819	PPPD-15	OPP-01	KLJ-I30	ML-M4

POLYGONAL TAPER TOOLING



TURNING TOOL HOLDERS - EXTERNAL

Screw Clamp
Direct Coolant Supply

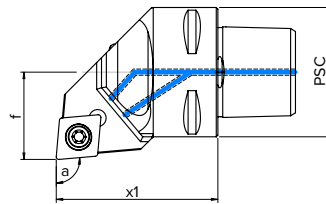

Size	Code	Orientation	Insert	PSC	a	x1	f
C4	C4-SCLCR-27050-12CP	Right	CC..1204..	40	95°	50	27
	C4-SCLCL-27050-12CP	Left	CC..1204..	40	95°	50	27
C5	C5-SCLCR-35060-12CP	Right	CC..1204..	50	95°	60	35
	C5-SCLCL-35060-12CP	Left	CC..1204..	50	95°	60	35
C6	C6-SCLCR-45065-12CP	Right	CC..1204..	63	95°	65	45
	C6-SCLCL-45065-12CP	Left	CC..1204..	63	95°	65	45

	Insert Screw	Shim	Shim Screw	Key	Key	Nozzle
Spare Parts						
Code:	VPT-4516	PPVC-12	VPP-4513	KLJ-I45	KLJ-T20	ML-M4

TURNING TOOL HOLDERS - EXTERNAL

Screw Clamp
External Coolant Supply

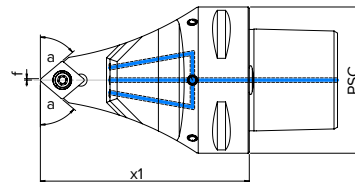

Size	Code	Orientation	Insert	PSC	a	x1	f
C6	C6-SCMCN-00090-12	Neutral	CC..1204..	63	50°	90	0

	Insert Screw	Shim	Shim Screw	Key	Key	Nozzle
Spare Parts						
Code:	VPT-4516	PPVC-12	VPP-4513	KLJ-I45	KLJ-T20	ML-M4

POLYGONAL TAPER TOOLING

TURNING TOOL HOLDERS - EXTERNAL

Screw Clamp
Direct Coolant Supply

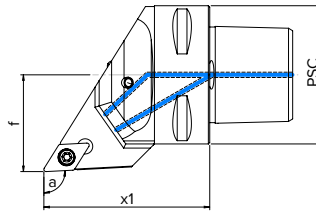

Size	Code	Orientation	Insert	PSC	a	x1	f
C4	C4-SDJCR-27050-11CP	Right	DC..11T3..	40	93°	50	27
	C4-SDJCL-27050-11CP	Left	DC..11T3..	40	93°	50	27
C5	C5-SDJCR-35060-11CP	Right	DC..11T3..	50	93°	60	35
	C5-SDJCL-35060-11CP	Left	DC..11T3..	50	93°	60	35
C6	C6-SDJCR-45065-11CP	Right	DC..11T3..	63	93°	65	45
	C6-SDJCL-45065-11CP	Left	DC..11T3..	63	93°	65	45

	Insert Screw	Shim	Shim Screw	Key	Key	Nozzle
Spare Parts						
Code:	VPT-3514	PPVD-11	VPP-3511	KLJ-I35	KLJ-T15	ML-M4

TURNING TOOL HOLDERS - EXTERNAL

Screw Clamp
Direct Coolant Supply

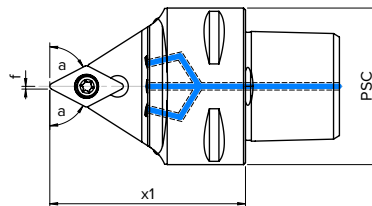

Size	Code	Orientation	Insert	PSC	a	x1	f
C4	C4-SDNCN-00050-11CP	Neutral	DC..11T3..	40	62.5°	50	0
C5	C5-SDNCN-00060-11CP	Neutral	DC..11T3..	50	62.5°	60	0

	Insert Screw	Shim	Shim Screw	Key	Key	Nozzle
Spare Parts						
Code:	VPT-3514	PPVD-11	VPP-3511	KLJ-I35	KLJ-T15	ML-M4





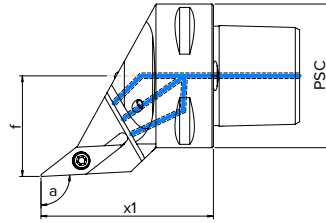

POLYGONAL TAPER TOOLING

TURNING TOOL HOLDERS - EXTERNAL

Screw Clamp
Direct Coolant Supply



Size	Code	Orientation	Insert	PSC	a	x1	f
C4	C4-SVJBR-27050-16CP	Right	VB(VC)..1604..	40	93°	50	27
	C4-SVJBL-27050-16CP	Left	VB(VC)..1604..	40	93°	50	27
C5	C5-SVJBR-35060-16CP	Right	VB(VC)..1604..	50	93°	60	35
	C5-SVJBL-35060-16CP	Left	VB(VC)..1604..	50	93°	60	35
C6	C6-SVJBR-45065-16CP	Right	VB(VC)..1604..	63	93°	65	45
	C6-SVJBL-45065-16CP	Left	VB(VC)..1604..	63	93°	65	45

	Insert Screw	Shim	Shim Screw	Key	Key	Nozzle
Spare Parts						
Code:	VPT-3508 (C4) VPT-3514 (C5,C6)	PPVV-16	VPP-3508	KLJ-I35	KLJ-T15	ML-M4

POLYGONAL TAPER TOOLING

TURNING TOOL HOLDERS - EXTERNAL

Screw Clamp
External Coolant Supply

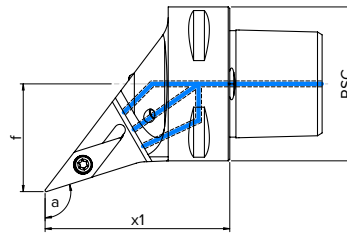

Size	Code	Orientation	Insert	PSC	a	x1	f
C4	C4-SVHBR-27050-16CP	Right	VB(VC)..1604..	40	107.5°	50	27
	C4-SVHBL-27050-16CP	Left	VB(VC)..1604..	40	107.5°	50	27
C5	C5-SVHBR-35060-16CP	Right	VB(VC)..1604..	50	107.5°	60	35
	C5-SVHBL-35060-16CP	Left	VB(VC)..1604..	50	107.5°	60	35
C6	C6-SVHBR-45065-16CP	Right	VB(VC)..1604..	63	107.5°	65	45
	C6-SVHBL-45065-16CP	Left	VB(VC)..1604..	63	107.5°	65	45

	Insert Screw	Shim	Shim Screw	Key	Key	Nozzle
Spare Parts						
Code:	VPT-3514	PPVV-16	VPP-3511	KLJ-I35	KLJ-T15	ML-M4

POLYGONAL TAPER TOOLING



TURNING TOOL HOLDERS - EXTERNAL

Screw Clamp
Direct Coolant Supply

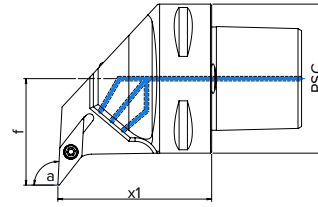

Size	Code	Orientation	Insert	PSC	a	x1	f
C6	C6-SVUBR-45065-16CP	Right	VB(VC)..1604..	63	93°	63	45
	C6-SVUBL-45065-16CP	Left	VB(VC)..1604..	63	93°	63	45

	Insert Screw	Shim	Shim Screw	Key	Key	Nozzle
Spare Parts						
Code:	VPT-3514	PPVV-16	VPP-3511	KLJ-I35	KLJ-T15	ML-M4

TURNING TOOL HOLDERS - EXTERNAL

Screw Clamp
Direct Coolant Supply

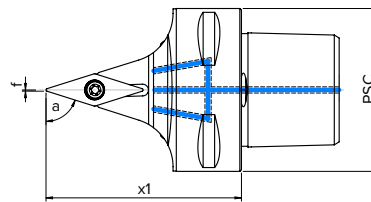

Size	Code	Orientation	Insert	PSC	a	x1	f
C4	C4-SVBN-00055-16CP	Neutral	VB(VC)..1604..	40	72.5°	55	0
C5	C5-SVBN-00060-16CP	Neutral	VB(VC)..1606..	50	72.5°	60	0
C6	C6-SVBN-00065-16CP	Neutral	VB(VC)..1608..	63	72.5°	65	0

	Insert Screw	Shim	Shim Screw	Key	Key	Nozzle
Spare Parts						
Code:	VPT-3514	PPVV-16	VPP-3511	KLJ-I35	KLJ-T15	ML-M4

POLYGONAL TAPER TOOLING

TURNING TOOL HOLDERS - EXTERNAL

Screw Clamp
Direct Coolant Supply

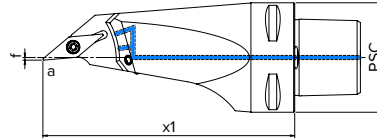

Size	Code	Orientation	Insert	PSC	a	x1	f
C5	C5-SVMBL-00115-16CP	Left	VB(VC)..1604..	50	95°	115	1,2
C6	C6-SVMBL-00130-16CP	Left	VB(VC)..1604..	63	95°	130	1,2
C6	C6-SVMBL-33120-16CP	Left	VB(VC)..1604..	63	95°	120	33

	Insert Screw	Shim	Shim Screw	Key	Key	Nozzle
Spare Parts						
Code:	VPT-3514	PPVV-16	VPP-3511	KLJ-I35	KLJ-T15	ML-M4

POLYGONAL TAPER TOOLING



TURNING TOOL HOLDERS - INTERNAL

Screw Clamp
Direct Coolant Supply

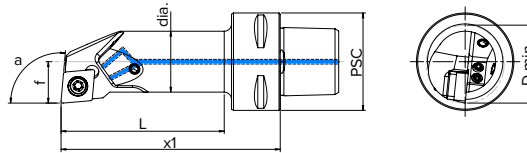

Size	Code	Orientation	Insert	PSC	a	x1	f	dia.	D min.	L
C4	C4-SCLCR-17090-12CP	Right	CC..1204..	40	95°	50	17	25	32	69
	C4-SCLCL-17090-12CP	Left	CC..1204..	40	95°	50	17	25	32	69
C5	C5-SCLCR-17090-12CP	Right	CC..1204..	50	95°	90	17	25	32	67
	C5-SCLCL-17090-12CP	Left	CC..1204..	50	95°	90	17	25	32	67

	Insert Screw	Shim	Shim Screw	Key	Key	Nozzle
Spare Parts						
Code:	VPT-4512	PPVC-12	VPP-4508	KLJ-I45	KLJ-T20	ML-M4

TURNING TOOL HOLDERS - INTERNAL

Screw Clamp
Direct Coolant Supply

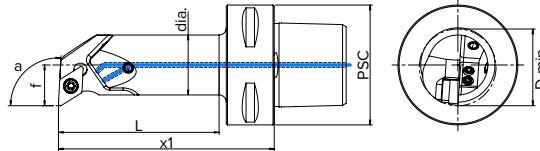

Size	Code	Orientation	Insert	PSC	a	x1	f	dia.	D min.	L
C4	C4-SDUCR-13080-11CP	Right	DC..11T3..	40	93°	80	13	20	25	58
	C4-SDUCL-13080-11CP	Left	DC..11T3..	40	93°	80	13	20	25	58
C4	C4-SDUCR-17090-11CP	Right	DC..11T3..	40	93°	90	17	20	25	58
	C4-SDUCL-17090-11CP	Left	DC..11T3..	40	93°	90	17	20	25	58
C5	C5-SDUCR-13080-11CP	Right	DC..11T3..	50	93°	80	13	25	32	69
	C5-SDUCL-13080-11CP	Left	DC..11T3..	50	93°	80	13	25	32	69
C5	C5-SDUCR-17090-11CP	Right	DC..11T3..	50	93°	90	17	25	32	69
	C5-SDUCL-17090-11CP	Left	DC..11T3..	50	93°	90	17	25	32	69

	Insert Screw	Shim	Shim Screw	Key	Key	Nozzle
Spare Parts						
Code:	VPT-3511	PPVD-11	VPP-3508	KLJ-I35	KLJ-T15	ML-M4

POLYGONAL TAPER TOOLING

TURNING TOOL HOLDERS - EXTERNAL THREAD

Screw Clamp
Direct Coolant Supply

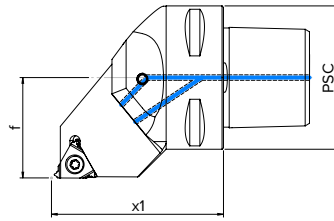

Size	Code	Orientation	Insert	PSC	x1	f
C4	C4-SER-27050-16CP	Right	16ER/L	40	50	27
	C4-SEL-27050-16CP	Left	16ER/L	40	50	27
C5	C5-SER-35060-16CP	Right	16ER/L	50	60	35
	C5-SEL-35060-16CP	Left	16ER/L	50	60	35
C6	C6-SER-45065-16CP	Right	16ER/L	63	65	45
	C6-SEL-45065-16CP	Left	16ER/L	63	65	45

	Insert Screw	Shim	Shim Screw	Key	Key	Nozzle
Spare Parts						
Code:	VPT-3514	PPVN-16	VPP-3511	KLJ-I35	KLJ-T15	ML-M4

POLYGONAL TAPER TOOLING



TURNING TOOL HOLDERS - INTERNAL THREAD

Screw Clamp
Direct Coolant Supply

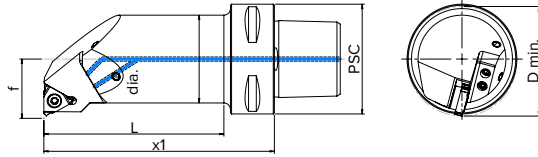

Size	Code	Orientation	Insert	PSC	x1	L	f	dia.	D min.
C4	C4-SIR-14060-16CP	Right	16IR/L	40	60	38	14	20	33
	C4-SIL-14060-16CP	Left	16IR/L	40	60	38	14	20	33
C4	C4-SIR-17070-16CP	Right	16IR/L	40	70	48	17	25	33
	C4-SIL-17070-16CP	Left	16IR/L	40	70	48	17	25	33
C4	C4-SIR-22090-16CP	Right	16IR/L	40	90	69	22	32	40
	C4-SIL-22090-16CP	Left	16IR/L	40	90	69	22	32	40
C5	C5-SIR-17070-16CP	Right	16IR/L	50	70	47	17	25	33
	C5-SIL-17070-16CP	Left	16IR/L	50	70	47	17	25	33
C5	C5-SIR-22090-16CP	Right	16IR/L	50	90	68	22	32	33
	C5-SIL-22090-16CP	Left	16IR/L	50	90	68	22	32	33
C5	C5-SIR-27105-16CP	Right	16IR/L	50	105	84	27	40	40
	C5-SIL-27105-16CP	Left	16IR/L	50	105	84	27	40	40
C6	C6-SIR-17075-16CP	Right	16IR/L	63	75	48	17	25	33
	C6-SIL-17075-16CP	Left	16IR/L	63	75	48	17	25	33
C6	C6-SIR-22090-16CP	Right	16IR/L	63	90	64	22	32	33
	C6-SIL-22090-16CP	Left	16IR/L	63	90	64	22	32	33
C6	C6-SIR-27105-16CP	Right	16IR/L	63	105	80	17	40	40
	C6-SIL-27105-16CP	Left	16IR/L	63	105	80	17	40	40

	Insert Screw	Shim	Shim Screw	Key	Key	Nozzle
Spare Parts						
Code:	VPT-3514	PPVN-16	VPP-3511	KLJ-I35	KLJ-T15	ML-M4

POLYGONAL TAPER TOOLING

RECTANGULAR SHANK ADAPTERS

Internal Coolant Supply

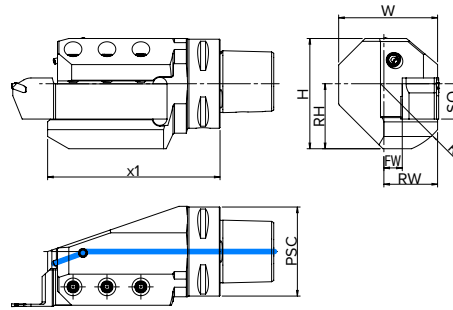

Radial	Size	Code	Orientation	PSC	x1	SQ	H	W	RH	RW	FW	R	bar	kg
	C5		C5-ASHR-095-20CP	Right	50	95	20	69	55.5	37	30	27	42.5	150
		C5-ASHL-095-20CP	Left	50	95	20	69	55.5	37	30	27	42.5	150	1.6
C6		C6-ASHR-105-20CP	Right	63	105	20	69	63.5	37	30	35	42.5	150	2.3
		C6-ASHL-105-20CP	Left	63	105	20	69	63.5	37	30	35	42.5	150	2.3
C6		C6-ASHR-122-25CP	Right	63	122	25	78	70.0	46	38	45	50	150	2.9
		C6-ASHL-122-25CP	Left	63	122	25	78	70.0	46	38	45	50	150	2.9
C8		C8-ASHR-122-25CP	Right	80	122	25	86	80.0	46	40	45	51.5	150	4.3
		C8-ASHL-122-25CP	Left	80	122	25	86	80.0	46	40	45	51.5	150	4.3

POLYGONAL TAPER TOOLING



RECTANGULAR SHANK ADAPTERS

Internal Coolant Supply

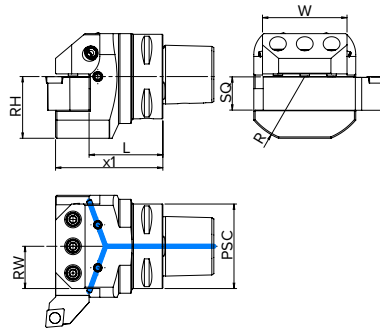

Axial	Size	Code	Orientation	PSC	x1	SQ	H	W	RW	R	bar	kg
	C5	C5-ASHA-065-20CP	Right/Left	50	65	20	45	64	32	42.5	150	1.4
	C6	C6-ASHA-080-25CP	Right/Left	63	70	25	50	64	32	42.5	150	1.8
	C6	C8-ASHA-075-25CP	Right/Left	80	75	25	50	80	38	51.5	150	3.0

RECTANGULAR SHANK ADAPTERS

Internal Coolant Supply

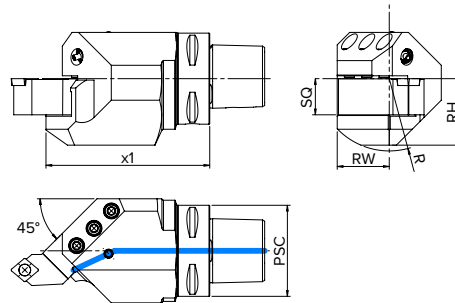

45°	Size	Code	Orientation	PSC	x1	SQ	RH	RW	R	bar	kg
C5		C5-ASHR45-085-20CP	Right	50	85	20	37	32	42.5	150	1.6
		C5-ASHL45-085-20CP	Left	50	85	20	37	32	42.5	150	1.6
C6		C6-ASHR45-114-25CP	Right	63	114	25	46	36	50	150	2.2
		C6-ASHL45-114-25CP	Left	63	114	25	46	36	50	150	2.2
C8		C8-ASHR45-135-32CP	Right	80	135	32	-	-	-	150	6.8
		C8-ASHL45-135-32CP	Left	80	135	32	-	-	-	150	6.8

POLYGONAL TAPER TOOLING

STATIC AND LIVE TOOLS FOR YOUR MACHINE

Engineered to increase the capabilities of a wide range of machines

Accuway	Hardinge
DMG MORI	Hurco
Doosan	Hyundai WIA
Emco	Jyoti
Focus CNC	Takamaz
Ganesh	Takisawa
Goodway	Victor Taichung
Haas	YCM

Additional Machines Coming Soon!



POLYGONAL TAPER TOOLING



STATIC AND LIVE TOOLS FOR YOUR MACHINE

Engineered to increase the capabilities of a wide range of machines



OD SINGLE HOLDER

- Right or left single OD quick coupling C4 holder



OD DOUBLE HOLDER

- Right or left double OD quick coupling C4 holder

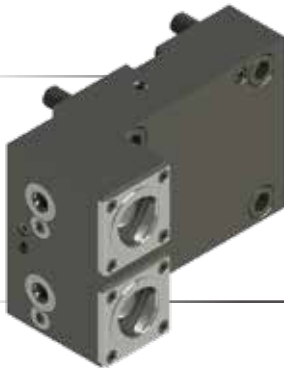

OD Y HOLDER

- Right or left Y-axis OD quick coupling C4 holder



OD DOUBLE Y HOLDER

- Right or left double Y-axis OD quick coupling C4 holder

STATIC AND LIVE TOOLS FOR YOUR MACHINE

Engineered to increase the capabilities of a wide range of machines

ID SINGLE HOLDER

- Right or left single ID quick coupling C4 holder



ID DOUBLE HOLDER

- Right or left double ID quick coupling C4 holder



ID Y HOLDER

- Right or left Y-axis ID quick coupling C4 holder



ID X HOLDER

- Right or left X-axis ID quick coupling C4 holder



ID DOUBLE Y HOLDER

- Right or left double Y-axis OD quick coupling C4 holder



POLYGONAL TAPER TOOLING



STATIC AND LIVE TOOLS FOR YOUR MACHINE

Engineered to increase the capabilities of a wide range of machines



OD DRIVEN HOLDER

- OD drilling or milling unit, C4 quick-coupling



ID DRIVEN HOLDER

- ID drilling or milling unit, C4 quick-coupling



ID CYLINDRICAL SHANK HOLDER

- ID holder for 40mm or 50mm cylindrical shanks



CUT OFF HOLDER

- Right, central, or left. A= 32mm

POLYGONAL TAPER TOOLING

ER COLLET CHUCKS

Internal Coolant Supply
 Radial Runout ≤ 0.003 mm
 G2.5 at 25 000 min⁻¹

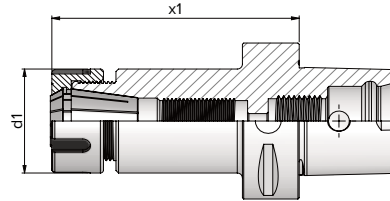

Size	Code	ER	Range	PSC	x1	d2
C4	C4-ER16-070	ER16	1 - 10	40	70	28
C4	C4-ER20-052	ER20	1 - 13	40	52	35
C4	C4-ER25-052	ER25	1 - 16	40	52	42
C4	C4-ER32-054	ER32	2 - 20	40	54	50
C5	C5-ER16-055	ER16	1 - 10	50	55	28
C5	C5-ER16-100	ER16	1 - 10	50	100	28
C5	C5-ER20-055	ER20	1 - 13	50	55	35
C5	C5-ER20-100	ER20	1 - 13	50	100	35
C5	C5-ER25-055	ER25	1 - 16	50	55	42
C5	C5-ER25-100	ER25	1 - 16	50	100	42
C5	C5-ER32-057	ER32	2 - 20	50	57	50
C5	C5-ER32-100	ER32	2 - 20	50	100	50
C5	C5-ER40-060	ER40	3 - 26	50	60	63
C6	C6-ER16-060	ER16	1 - 10	63	60	28
C6	C6-ER16-100	ER16	1 - 10	63	100	28
C6	C6-ER20-060	ER20	1 - 13	63	60	35
C6	C6-ER20-100	ER20	1 - 13	63	100	35
C6	C6-ER25-060	ER25	1 - 16	63	60	42
C6	C6-ER25-100	ER25	1 - 16	63	100	42
C6	C6-ER32-060	ER32	2 - 20	63	60	50
C6	C6-ER32-100	ER32	2 - 20	63	100	50
C6	C6-ER32-130	ER32	2 - 20	63	130	52
C6	C6-ER40-065	ER40	3 - 26	63	65	63
C6	C6-ER40-120	ER40	3 - 26	63	120	63
C8	C8-ER16-065	ER16	1 - 10	80	65	28
C8	C8-ER16-100	ER16	1 - 10	80	100	28
C8	C8-ER20-065	ER20	1 - 13	80	65	35
C8	C8-ER20-100	ER20	1 - 13	80	100	35
C8	C8-ER25-070	ER25	1 - 16	80	70	42
C8	C8-ER25-100	ER25	1 - 16	80	100	42
C8	C8-ER25-130	ER25	1 - 16	80	130	42
C8	C8-ER25-160	ER25	1 - 16	80	160	42
C8	C8-ER32-070	ER32	1 - 16	80	70	50
C8	C8-ER32-100	ER32	2 - 20	80	100	50
C8	C8-ER32-130	ER32	2 - 20	80	130	50
C8	C8-ER32-160	ER32	2 - 20	80	160	50
C8	C8-ER40-070	ER40	3 - 26	80	70	63

POLYGONAL TAPER TOOLING

ER COLLET CHUCKS - SHORT ADAPTER

Internal Coolant Supply

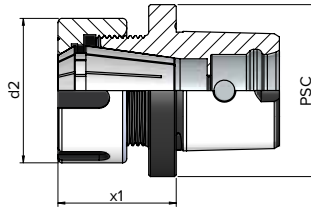

Size	Code	ER	Range	PSC	x1	d2
C4	C4-ER20-032	ER20	1 - 13	40	32	35
C4	C4-ER25-035	ER25	1 - 16	40	35	42
C4	C4-ER32-052	ER32	2 - 20	40	52	50
C5	C5-ER25-034	ER25	1 - 16	50	34	42
C5	C5-ER32-041	ER32	2 - 20	50	41	50
C5	C5-ER40-058	ER40	3 - 26	50	58	63
C6	C6-ER32-042	ER32	2 - 20	63	42	50
C6	C6-ER40-048	ER40	3 - 26	63	48	63

POLYGONAL TAPER TOOLING

“3 IN 1” THERMO SHRINK-FIT CHUCKS

Internal and/or Direct Coolant Supply
 Radial Runout ≤ 0.003 mm
 G2.5 at 25 000 min⁻¹

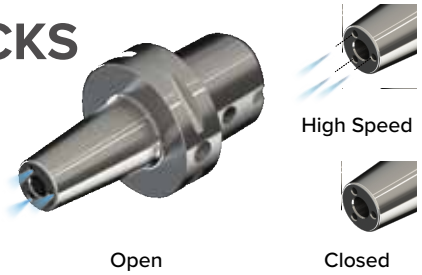
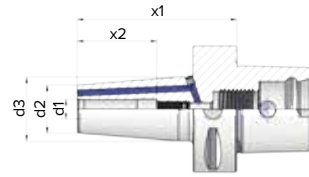

Size	Code	d1	PSC	x1	d2	d3	x2
C4	C4-SF03-075	3	40	75	9	16	–
C4	C4-SF03-120	3	40	120	9	16	–
C4	C4-SF04-075	4	40	75	10	17	–
C4	C4-SF04-120	4	40	120	10	17	–
C4	C4-SF05-075	5	40	75	11	18	–
C4	C4-SF05-120	5	40	120	11	18	–
C4	C4-SF06-075-CP	6	40	75	20	27	36
C4	C4-SF06-120-CP	6	40	120	20	27	36
C4	C4-SF08-075-CP	8	40	75	20	27	36
C4	C4-SF08-120-CP	8	40	120	20	27	36
C4	C4-SF10-075-CP	10	40	75	24	32	42
C4	C4-SF10-120-CP	10	40	120	24	32	42
C4	C4-SF12-075-CP	12	40	75	24	32	47
C4	C4-SF12-120-CP	12	40	120	24	32	47
C4	C4-SF14-080-CP	14	40	80	27	34	47
C4	C4-SF14-120-CP	14	40	120	27	34	47
C4	C4-SF16-080-CP	16	40	80	27	34	50
C4	C4-SF16-120-CP	16	40	120	27	34	50
C5	C5-SF03-075	3	50	75	9	16	–
C5	C5-SF03-120	3	50	120	9	16	–
C5	C5-SF04-075	4	50	75	10	17	–
C5	C5-SF04-120	4	50	120	10	17	–
C5	C5-SF05-075	5	50	75	11	18	–
C5	C5-SF05-120	5	50	120	11	18	–
C5	C5-SF06-075-CP	6	50	75	20	27	36
C5	C5-SF06-120-CP	6	50	120	20	27	36
C5	C5-SF08-075-CP	8	50	75	20	27	36
C5	C5-SF08-120-CP	8	50	120	20	27	36
C5	C5-SF10-075-CP	10	50	75	24	32	42
C5	C5-SF10-120-CP	10	50	120	24	32	42
C5	C5-SF12-075-CP	12	50	75	24	32	47
C5	C5-SF12-120-CP	12	50	120	24	32	47
C5	C5-SF14-080-CP	14	50	80	27	34	47
C5	C5-SF14-120-CP	14	50	120	27	34	47
C5	C5-SF16-080-CP	16	50	80	27	34	50
C5	C5-SF16-120-CP	16	50	120	27	34	50
C5	C5-SF18-080-CP	18	50	80	33	42	50
C5	C5-SF18-120-CP	18	50	120	33	42	50
C5	C5-SF20-085-CP	20	50	85	33	42	52
C5	C5-SF20-120-CP	20	50	120	33	42	52

POLYGONAL TAPER TOOLING



“3 IN 1” THERMO SHRINK-FIT CHUCKS

Internal and/or Direct Coolant Supply
 Radial Runout ≤ 0.003 mm
 G2.5 at 25 000 min⁻¹

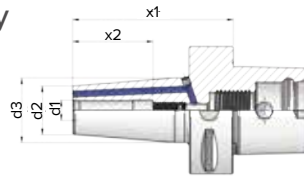

Open

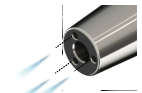

High Speed



Closed

Size	Code	d1	PSC	x1	d2	d3	x2
C6	C6-SF03-080	3	63	75	9	16	–
C6	C6-SF03-120	3	63	120	9	16	–
C6	C6-SF04-080	4	63	75	10	17	–
C6	C6-SF04-120	4	63	120	10	17	–
C6	C6-SF05-080	5	63	80	11	18	–
C6	C6-SF05-120	5	63	120	11	18	–
C6	C6-SF06-080-CP	6	63	80	20	27	36
C6	C6-SF06-120-CP	6	63	120	20	27	36
C6	C6-SF08-080-CP	8	63	80	20	27	36
C6	C6-SF08-120-CP	8	63	120	20	27	36
C6	C6-SF10-080-CP	10	63	80	24	32	42
C6	C6-SF10-120-CP	10	63	120	24	32	42
C6	C6-SF12-080-CP	12	63	80	24	32	47
C6	C6-SF12-120-CP	12	63	120	24	32	47
C6	C6-SF14-085-CP	14	63	85	27	34	47
C6	C6-SF14-120-CP	14	63	120	27	34	47
C6	C6-SF16-085-CP	16	63	85	27	34	50
C6	C6-SF16-120-CP	16	63	120	27	34	50
C6	C6-SF18-085-CP	18	63	85	33	42	50
C6	C6-SF18-120-CP	18	63	120	33	42	50
C6	C6-SF20-085-CP	20	63	85	33	42	52
C6	C6-SF20-120-CP	20	63	120	33	42	52
C6	C6-SF25-090-CP	25	63	90	44	53	58
C6	C6-SF25-120-CP	25	63	120	44	53	58
C6	C6-SF32-095-CP	32	63	95	44	53	63
C6	C6-SF32-120-CP	32	63	120	44	53	63

POLYGONAL TAPER TOOLING

“3 IN 1” THERMO SHRINK-FIT CHUCKS

Internal and/or Direct Coolant Supply
 Radial Runout ≤ 0.003 mm
 G2.5 at 25 000 min⁻¹

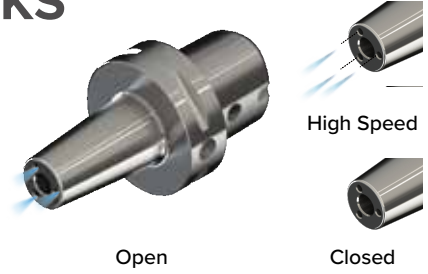
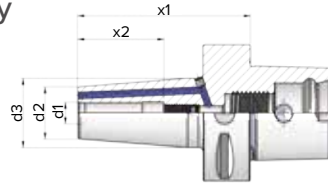

Size	Code	d1	PSC	x1	d2	d3	x2
C8	C8-SF03-085	3	80	85	9	16	–
C8	C8-SF03-130	3	80	130	9	16	–
C8	C8-SF04-085	4	80	85	10	17	–
C8	C8-SF04-130	4	80	130	10	17	–
C8	C8-SF05-085	5	80	85	11	18	–
C8	C8-SF05-130	5	80	130	11	18	–
C8	C8-SF06-085-CP	6	80	85	20	27	36
C8	C8-SF06-130-CP	6	80	130	20	27	36
C8	C8-SF08-085-CP	8	80	85	20	27	36
C8	C8-SF08-130-CP	8	80	130	20	27	36
C8	C8-SF10-085-CP	10	80	85	24	32	42
C8	C8-SF10-130-CP	10	80	130	24	32	42
C8	C8-SF12-085-CP	12	80	85	24	32	47
C8	C8-SF12-130-CP	12	80	130	24	32	47
C8	C8-SF14-085-CP	14	80	85	27	34	47
C8	C8-SF14-130-CP	14	80	130	27	34	47
C8	C8-SF16-090-CP	16	80	90	27	34	50
C8	C8-SF16-130-CP	16	80	130	27	34	50
C8	C8-SF18-090-CP	18	80	90	33	42	50
C8	C8-SF18-130-CP	18	80	130	33	42	50
C8	C8-SF20-090-CP	20	80	90	33	42	52
C8	C8-SF20-130-CP	20	80	130	33	42	52
C8	C8-SF25-090-CP	25	80	90	44	53	58
C8	C8-SF25-130-CP	25	80	130	44	53	58
C8	C8-SF32-090-CP	32	80	90	44	53	63
C8	C8-SF32-130-CP	32	80	130	44	53	63

POLYGONAL TAPER TOOLING



“3 IN 1” THERMO SHRINK-FIT CHUCKS SHORT ADAPTERS

Internal and/or Direct
Coolant Supply

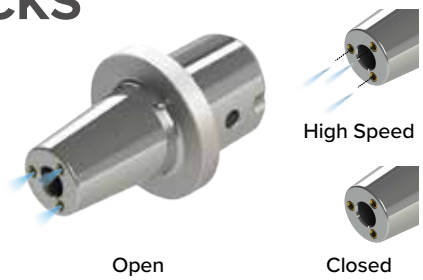
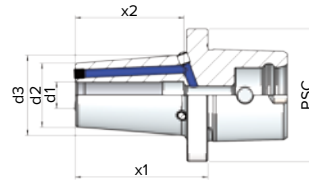

Size	Code	d1	PSC	x1	d2	d3	x2
C4	C4-SF06-049-CP	6	40	49	20	24.5	36
C4	C4-SF08-049-CP	8	40	49	20	24.5	36
C4	C4-SF10-049-CP	10	40	49	24	28.5	41
C4	C4-SF12-049-CP	12	40	49	24	28.5	46
C4	C4-SF14-049-CP	14	40	49	27	31.5	46
C4	C4-SF16-054-CP	16	40	54	27	32.3	49
C5	C5-SF06-050-CP	6	50	50	20	24.5	36
C5	C5-SF08-050-CP	8	50	50	20	24.5	36
C5	C5-SF10-050-CP	10	50	50	24	28.5	41
C5	C5-SF12-050-CP	12	50	50	24	28.5	46
C5	C5-SF14-050-CP	14	50	50	27	31.5	46
C5	C5-SF16-055-CP	16	50	55	27	32.3	49
C6	C6-SF06-052-CP	6	63	52	20	24.5	36
C6	C6-SF08-052-CP	8	63	52	20	24.5	36
C6	C6-SF10-052-CP	10	63	52	24	28.5	41
C6	C6-SF12-052-CP	12	63	52	24	28.5	46
C6	C6-SF14-052-CP	14	63	52	27	31.5	46
C6	C6-SF16-057-CP	16	63	57	27	32.3	49

SHELL MILL HOLDERS

Internal Coolant Supply
 Radial Runout ≤ 0.003 mm
 G2.5 at 25 000 min⁻¹

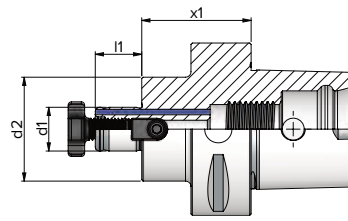

Size	Code	d1	PSC	x1	d2	l1
C4	C4-SM16-035-IK	16	40	35	28	17
C4	C4-SM22-025-IK	22	40	25	48	19
C5	C5-SM16-035-IK	16	50	35	38	17
C5	C5-SM22-025-IK	22	50	25	48	19
C5	C5-SM27-025-IK	27	50	25	56	21
C5	C5-SM32-040-IK	32	50	40	63	24
C6	C6-SM16-040-IK	16	63	40	38	17
C6	C6-SM22-025-IK	22	63	25	48	19
C6	C6-SM27-025-IK	27	63	25	56	21
C6	C6-SM32-040-IK	32	63	40	63	24
C6	C6-SM40-050-IK	40	63	50	87	27
C8	C8-SM16-050-IK	16	80	50	38	17
C8	C8-SM22-030-IK	22	80	30	48	19
C8	C8-SM27-030-IK	27	80	30	56	21
C8	C8-SM32-030-IK	32	80	30	63	24
C8	C8-SM40-060-IK	40	80	60	87	27



SHELL MILL HOLDERS - SHORT ADAPTERS

Internal Coolant Supply

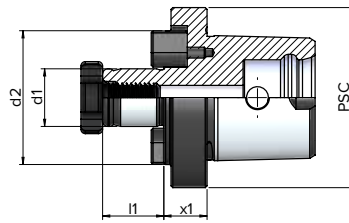

Size	Code	d1	PSC	x1	d2	l1
C4	C4-SM16-010	16	40	10	40	17
C4	C4-SM22-012	22	40	12	45	19
C5	C5-SM16-010	16	50	10	50	17
C5	C5-SM22-012	22	50	12	50	19
C5	C5-SM27-012	27	50	12	50	21
C5	C5-SM32-018	32	50	18	63	24
C6	C6-SM16-010	16	63	10	63	17
C6	C6-SM22-010	22	63	10	63	19
C6	C6-SM27-011	27	63	11	63	21
C6	C6-SM32-012	32	63	12	63	24

A photograph of the Lyndex-Nikken building facade, featuring the company name and logo in large letters above a glass entrance. The image is overlaid with a blue tint.

LYNDEX
NIKKEN

ABOUT US

At Lyndex-Nikken, we have made it our mission to provide the two most important points to keep you ahead of the competition: advanced technology and the innovation to keep it moving forward. In addition to manufacturing the best machine tool accessories available on the market, our team of highly experienced technicians and product specialists offers unmatched customer service and engineering support to our customers worldwide.



1468 Armour Boulevard | Mundelein, IL 60060
Phone: 847.367.4800 | Fax: 847.367.4815 | sales@lyndexnikken.com
www.lyndexnikken.com

